

checkbox

Wireless Systems



HSv625 WiFi Controller



Set Up & User Guide



CheckBox Wireless Systems™ are designed to be Easy to Install, Easier to Manage and Easiest to Afford. To make set up as easy as possible, please take a moment to completely read through these instructions before you begin.



Welcome

We have designed CheckBox Wireless Systems™ to be easy to install, easier to manage and easiest to afford. For best results please take the time to read through this booklet completely before you begin setup. The answer to most questions can be found in here.

We are constantly working to add new features to CheckBox, and as these features are developed they will be added to your system via automatic system updates. These updates may change the way some of your administration screens appear and how features function. To keep current on these new features you can download an updated version of this booklet at www.CheckBoxSystems.net

Thank you for purchasing a CheckBox System!

Table of Contents

Installing CheckBox

Connecting CheckBox	4
Installing the CheckBox H5v625 Controller	5
Logging into your management screens	6
Assigning flexible ports	7
Network setup	8
Wireless access points	9
Setting up and using MultiNet	10
Guest networks	10
Admin networks	11
Setting up guest access	13
Using credit cards and PayPal	14
Free access	15
Permacode	16
Room prompt setup	16
Customizing the welcome screen	17
Uploading graphics	18
Accessing the system from the outside	19
Accessing the system from the Internet	21
Administering active clients	21
Manually authorizing devices	22
Client usage policy	23
Network statistics	24
Signal strength, power levels and antennas	25
Meshing access points & mesh node status display	27
Final installation checklist	29
CheckBox S/A/F/E - the Survey And Feedback Engine	30
Setting up CheckBox S/A/F/E	31
Receiving and responding to messages with S/A/F/E	34
Creating guest surveys with S/A/F/E	35
S/A/F/E guest contact information	36
System alerts	37
Included and optional services	38
Warranty information	Back cover

Connecting CheckBox

The best way to connect your CheckBox System is directly to your Internet connection(s). It can also be connected through a switch or dedicated firewall system, which may require some configuration on your switch or firewall.

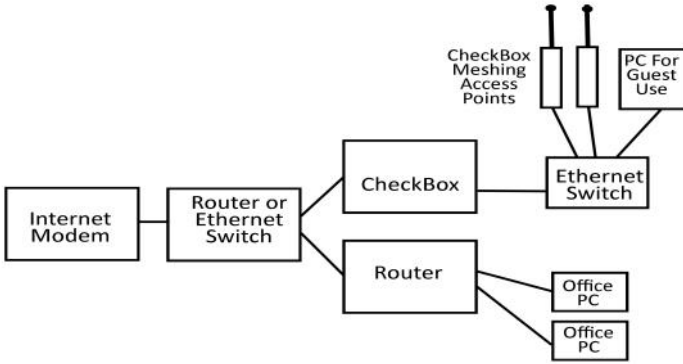

You may also use an Ethernet switch attached to your CheckBox to connect multiple CheckBox Meshing Access Points. When connecting multiple access points or guest PCs to the CheckBox be sure to use an Ethernet switch and not a router—routers plugged into the guest network after CheckBox will cause issues with guests being properly authenticated and managed.

Please note - If you are using the private administrative network then any device plugged into the CheckBox will be on the private network and not on a guest network.

An Important note on surge protection

Your CheckBox controller and access points are built to withstand power surges caused by electrical fluctuations. Large surges caused by power spikes from the power company, other devices sharing the power circuit or nearby lightning strikes can damage any electronic device, including your CheckBox controller or access points. This damage could cause immediate or delayed failure.

To reduce the risk of damage your CheckBox controller should be connected to an outlet that is not shared by devices that have high start up current demands (such as air conditioners, coolers, or any device with a large motor) and protected by a good quality surge protector. If you regularly experience power glitches or power failures you should use a UPS (Uninterruptible Power Supply) for additional protection. Your modem, switches and firewall devices should all be on the same surge protector and UPS.



Power spikes, particularly spikes from nearby lightning strikes, can also spread through your system through long runs of Ethernet cables that run outside. For long outdoor cable runs, or cable runs between building use fiber optic cables instead of Ethernet cables. Fiber optic cables will not transmit power spikes and provide an effective barrier to contain potential damage from power spikes and lightning strikes.

Installing The CheckBox HSv625 Controller

Locating the equipment

The CheckBox HSv625 must be located indoors in a clean, dry area and should be located close to power and the Internet connection(s)

Connecting the equipment

The CheckBox HSv625 will connect to your modem using an Ethernet network cable. Depending upon your particular modem the jack may be marked “Internet”, “LAN”, “PC”, “Host” or something else.

The CheckBox HSv625 can connect three different Internet connections and provides automatic load balancing and automatic failover switching.

Connect your CheckBox HSv625 as follows:

- The Local Port connects to your access points or networks switches connecting your access points.
- Ports A and B are flexible ports that can be connected to either Internet connections or to your access points or networks switches connecting your access points.
- The Internet Port connects to your first Internet connection.



Ports A and B are flexible and can be used for either additional Internet connections or as local ports. However before they can be used you need to select what role they will be used in.

It is O.K. to connect the cables first, but by default the ports are deactivated and you will need to set their role before the system will recognize them. See page 7.

Your CheckBox HSv625 is equipped with 2.5Gigabit Ethernet ports. Many Ethernet switches and computers are equipped with Gigabit ports—they are only capable of one gigabit of throughput.

Your HSv625 will work with the slower ports, however to get the best performance from your HSv625 use Ethernet devices (switches, modems etc.) that have 2.5 Gigabit ports.

Logging into your Administration screens

The administration screens are used to manage your system, create and print tickets for your users and view your system status. The administration screens also allow you to view users on the system, view tickets not yet used, and to delete tickets from the system. These screens are accessed through a web browser, and can be accessed from inside the system or from outside the system from anywhere. To learn how to access the system remotely see **Accessing Your System from the Internet** section in this guide.

To access CheckBox locally make sure your computer is connected to the CheckBox, *either by a wireless connection or through a wired Ethernet port connected to the CheckBox controller*. If you are connecting wirelessly select the wireless network “hotspot”, the default name for the CheckBox wireless network. You can change this name later.

Open your web browser and you should see a generic welcome screen.

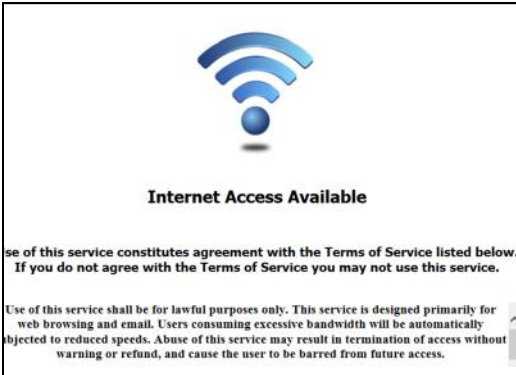

This is the welcome screen your guests will see when they first log on to your system and you can customize this screen. From here your guests are prompted to enter a ticket number, credit card or use any of the access methods that you have enabled before they can connect to the internet. To access the administration screens enter the following in the address bar.

<http://192.168.17.1:3456/admin>

This will bring up a page warning you that no password has yet been set for

the administration screens for your CheckBox. Create a password that is a combination of letters and numbers. Do not use any spaces or special characters (such as **&**, *****, **@**, **!**)

Enter your chosen password twice and press **Set Password**. A box will pop up so that you can test your password. If your are asked for a user name, leave the user name box empty.

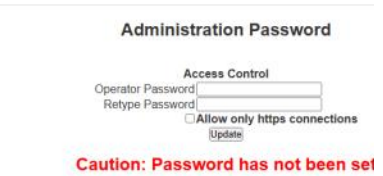

Assigning Flexible Ports

Your CheckBox HSv625 has four 2.5 Gigabit capable Ethernet network ports. One port is dedicated for local connections—connecting to your access points and switches serving devices on your network. Another port is dedicated for the first Internet connection.

There are two ports, labelled A and B can be used for either local or Internet connections.

By default the two flexible ports are deactivated. If you plug a cable into one of these ports they system will ignore the connection until you assign the port as Local or Internet.

Normally you will only make changes to these ports when you first set up your CheckBox or after adding or deleting an Internet connection.

To change port assignments go to Network Setup -> Port Assignment.

Select the port you want to activate and click on it to cycle through different settings:

Not Used -> Internet -> Local and then back to Not Used again.

After you have made the selections for each port press the update button below.

Current Internet Configuration

Internet Port - Comcast		
Mac: 52:54:00:57:08:7E	Ethernet: 2500Mb/s	Duplex: full
Ip: 198.50.192.13	Netmask: 255.255.255.240	Gateway: 198.50.192.1
Recent Data Rate: 26.1 Kbps	Maximum Data Rate: 294.2 Kbps	
Recent Uplink Rate: 147.6 Kbps	Maximum Uplink Rate: 895.0 Kbps	
<input type="button" value="Setup"/>		<input type="button" value="Link Speed Test"/>
Port B - Verizon		
Mac: 52:54:00:5F:69:9F	Ethernet: 1000Mb/s	Duplex: full
Ip: 198.50.192.14	Netmask: 255.255.255.240	Gateway: 198.50.192.1
Recent Data Rate: 1.9 Kbps	Maximum Data Rate: 117.7 Kbps	Loadshare: 28%
Recent Uplink Rate: 0.0 bps	Maximum Uplink Rate: 2.9 Kbps	
<input type="button" value="Setup"/>		<input type="button" value="Link Speed Test"/>

Port Speed Color Codes

2.5 Gigabit Gigabit 100mbit 10mbit Unplugged

- * Link speed test will measure the internet connection from that port to the internet.
 - * The test will attempt to download from multiple servers to stress that network connection.
 - * Guest client traffic will be included in the totals.
- *Please note:** This test runs on the checkbox controller, and is not affected by capabilities of your device

Depending upon the change made your system may require a reboot. If a reboot is required you will be prompted to confirm the reboot. Your system will then reboot, taking about 90 seconds to complete the reboot.

If you have added any Internet connections and those connections need to be assigned a static Ip address you will need to go to Network Setup -> Internet and enter your static IP information for each connection requiring static IPs. If your connection does not need static IPs you can skip this step.

If you have stopped using a port that is set up as Internet, deactivating the port will free up system resources and in some case may slightly improve system performance.

Network Setup

You probably will not need to make any changes in the network setup of your CheckBox system as most Internet Service Providers use DHCP, Dynamic Host Configuration Protocol, to tell the devices connected to their network what address and other parameters to use.

If your Internet Service Provider uses static IP addresses, or if you are connecting CheckBox to an internal company network you may need to set some network parameters manually.

To enter Network Setup click on **Network Setup** then **Internet**. A page titled **Current Internet Configuration** will appear.

On this page you will see a summary of the Internet connections currently connected to each of the ports assigned as Internet on your CheckBox. Only Internet ports that have been activated will be displayed here.

This page will show you the recent data rates (speed) and maximum data rate on each link. CheckBox will use this information to determine the percentage of the data traffic that each connection will carry, and will adjust this percentage on the fly.

If the Internet connection is set for DHCP (automatic configuration) the IP address received via DHCP will be displayed here.

If you need to set a fixed (static or permanent IP address) click on **Setup** and then enter the IP address, Netmask, Gateway and DNS information in the appropriate boxes. Click Update and then restart your system.

You can test each Internet connection's speed by clicking on **Link Speed Test**.

Current Internet Configuration

Internet Port - Comcast		
Mac: 52:54:00:57:08:7E	Ethernet: 2500Mb/s	Duplex: full
Ip: 198.50.192.13	Netmask: 255.255.255.240	Gateway: 198.50.192.1
Recent Data Rate: 26.1 Kbps	Maximum Data Rate: 294.2 Kbps	
Recent Uplink Rate: 147.6 Kbps	Maximum Uplink Rate: 895.0 Kbps	
<input type="button" value="Setup"/>		<input type="button" value="Link Speed Test"/>
Port B - Verizon		
Mac: 52:54:00:5F:69:9F	Ethernet: 1000Mb/s	Duplex: full
Ip: 198.50.192.14	Netmask: 255.255.255.240	Gateway: 198.50.192.1
Recent Data Rate: 1.9 Kbps	Maximum Data Rate: 117.7 Kbps	Loadshare: 28%
Recent Uplink Rate: 0.0 bps	Maximum Uplink Rate: 2.9 Kbps	
<input type="button" value="Setup"/>		<input type="button" value="Link Speed Test"/>

Port Speed Color Codes

2.5 Gigabit	Gigabit	100mbit	10mbit	Unplugged
-------------	---------	---------	--------	-----------

- * Link speed test will measure the internet connection from that port to the internet.
- * The test will attempt to download from multiple servers to stress that network connection.
- * Guest client traffic will be included in the totals.
- *Please note: This test runs on the checkbox controller, and is not affected by capabilities of your device

Local Address

Local Address refers to the IP addresses the CheckBox system assigns to users on the system. By default this address is in the 192.168.17.xxx range. This setting does not need to be changed under most circumstances. If there is a need to change this address range, select **Network Setup** and then **Local** and enter the new address range in here and press update.

NEVER SET THE LOCAL ADDRESS RANGE TO BE THE SAME AS THE ADDRESS RANGE OF THE INTERNET CONNECTION. This will cause routing errors and you will lose contact with the unit.

Wireless Access Points

The CheckBox HSv625 can host and manage CheckBox meshing access points in wired and wireless modes.

The SSID is the Service Set Identification - the name of a wireless network that is broadcast to announce the network's presence.

When using CheckBox mesh node access points the SSID and channel of the access points is set are controlled from within the management screens of the CheckBox. If you are using other brands of access points you will need to configure and manage them manually.

By default the SSID is "hotspot". To change the SSID select **Network Setup** and then **Wireless Multinet**. Select which network you wish to change and then Enter the new name and press update. It is important that your name contain only letters and numbers - no spaces or symbols.

If you are using access points in a wireless mesh configuration allow 10 minutes after update for the access points to reconfigure their SSID. During this period do not make any other system changes (i.e. Local Address or channel) or you run the risk of the access points becoming lost.

Network Throughput Test

You can test the speed of the connection between devices on your property and the CheckBox controller by connecting to your admin page with a phone, tablet or laptop via WiFi and then going to **Network Setup -> Network Test**.

This will test the connection from your WiFi device (phone/tablet etc.) through your access points and to the CheckBox controller. Test results will be affected by factors including other users, interference and the Client Usage Policy. This will help you determine the kind of system performance your guests can expect.

checkbox

Dashboard

Administration

Access Controls

Customize Site

Mesh

Network Setup

Checkbox Network Throughput Test

Download	Upload
Mbps	Mbps

Start

- * This test does **NOT** measure your internet connection.
- * This test measures the bandwidth between your device and the Checkbox controller.
- * This test is meant to help identify areas on the property with poor wifi reception.

Please note: If logged in remotely over the internet, results of this test will be meaningless.

Please note: This test uses browser based Javascript to complete
Most browsers are not capable of measuring a 10 gigabit connection at full speed

Setting Up & Using MultiNet

MultiNet allows you to provide multiple independent Wi-Fi networks for guests and encrypted management networks for staff all with one CheckBox System.

With MultiNet you can

- Create a basic and a premium guest network, with different bandwidth limits.
- Create guest networks with different branding and different welcome pages, such as one for the entire property and one for a restaurant on the property.
- Provide separate private networks that are encrypted for staff to use.

With MultiNet each access point can broadcast multiple networks simultaneously.

MultiNet is not compatible with third party access points.

To Setup an additional network using MultiNet go to **Network Setup > Wireless MultiNet**.

By default only Guest Network 1 is enabled. Here you can disable or enable other networks, change the SSID (the name the network broadcasts to devices, and choose Client Isolation and P2P Inhibit options. After making changes press **Update**. Changes may take a few moments to take effect, and if you are connected to the CheckBox wirelessly your connection may be dropped.



Guest Network 2

If you would like to enable a second guest network select **Guest Network 2**.

You will not be able to set the options for Guest Network 2 until you select **Enabled**.

After enabling the second guest network, set your SSID and choose Client Isolation and P2P Inhibiting options if appropriate. *The SSID must be different than the SSID used for your first guest network or your admin network.*

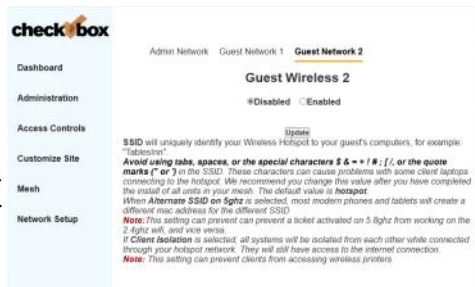

Select **Update** and wait a few minutes as the system reconfigures the access points and adds the additional network.

Your second guest network will have its own welcome page, separate graphics and branding and its own set of rules and tickets and PermaCodes. You can set up the welcome page and other options under **Customize Site** and **Access Controls**.

Admin Network

With CheckBox you can add private networks for management use. These networks don't use tickets or PermaCodes like the guest network, And they are secured with WPA2 encryption.

If you would like to enable an Admin Network select Network Setup > Wireless MultiNet > Admin Network and enable the network.

You will not be able to set the options for the Admin Network until you select Enabled.

After enabling the Admin Network, set your SSID and WPA2 key. *The SSID must be different than the SSID used for your guest network(s) or your admin network. A WPA2 key is required to set up the Admin Network.*

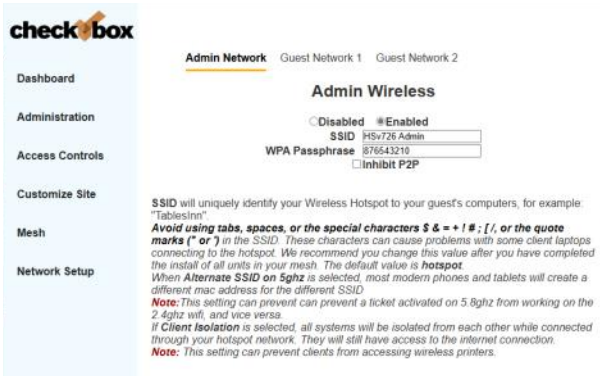

The WPA key is a private key or password used by devices connecting to the admin network. This key should never be shared with guests and only shared with employees that need it to set up and manage devices on the Admin Network. The WPA key can be any string of numbers and letters you choose, but can not include spaces or symbols. It must be at least 8 characters long and can be as long as 63 characters. The longer the string the more secure the key is.

After entering your WPA2 key select **Update**. And Wait.

Adding an additional network can take several minutes as the system has to set up the network routes and update the access points. If you are connected to the CheckBox wirelessly your connection may be dropped.

If you are using access points in a wireless mesh configuration allow 10 minutes after update for the access points to reconfigure their SSID. During this period do not make any other system changes (i.e. Local Address or channel) or you run the risk of the access points becoming lost.



Setting up Guest Access

In order for guests to access the Internet through your CheckBox System they have to be authenticated. There are several ways your guests can authenticate, including:

Access Tickets

PermaCodes

Credit Cards and PayPal

Free Access

Third Party Systems such as reservation or point-of-sale.*

*Your CheckBox can also be tied to your company loyalty card rewards program and integrated into point-of-sale systems. For more information on integrating CheckBox with loyalty programs and point-of-sale systems please contact CheckBox Support.

When setting up guest access the system will automatically generate the appropriate buttons and boxes on your welcome screen; If you have not printed any tickets and have enabled free access and credit cards, then the system will not display a box to enter access tickets. If you have not enabled credit card payments or free access and have created tickets then only the ticket box will be displayed on your welcome screen. If you have not enabled free access or printed tickets and have enabled credit cards then only the credit card buttons will be displayed.

Generate Tickets allow you to create and distribute tickets for your guests that allow them an amount of time online that you determine. These tickets can be good for an amount of time ranging from 15 minutes to one year. You can give these tickets away or sell them.

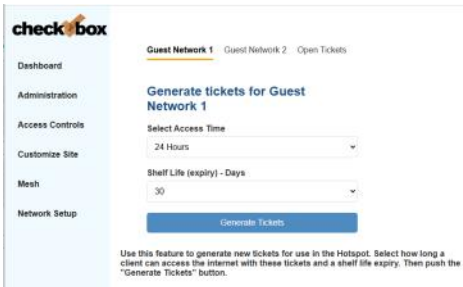

Tickets can only be used by one device and guest can not share tickets or re-use them.

To create tickets click on **Access Controls > Generate Tickets**. If you have more than one Guest Network make sure you select the Network you want to create tickets for. Select the duration of the tickets you wish to generate and their expiry date (shelf life) and then click on the **Generate Tickets** button.

A new window will open with a sheet of ten tickets that you can print on a standard printer. The sheet can be cut up, or you can use standard business card stock (Avery 5870 or equivalent) and the tickets will print on the cards.

If you do not see the window of tickets open after selecting **Generate Tickets** be sure that you have pop up blockers disabled or that you allow pop ups from the site.

The Graphic on the ticket can be changed under **Customize Site**.



With CheckBox you can accept credit cards automatically through the welcome page. CheckBox uses the PayPal system to clear the transactions and deposit the funds into your account, and allows you to set the pricing and duration. Using credit cards you do not need to be present to hand out tickets - great for unattended locations such as marinas and public spaces.

Using Credit Cards & PayPal

To accept credit cards and PayPal you will need a Business Account with PayPal if you do not already have one. Go to www.paypal.com to setup an account. (If you have an existing personal account you can upgrade to a business account). *Make Sure you specify a Business Account when setting up your PayPal Account*

PayPal access is only available on Guest Network 1.

After your PayPal Business account setup has been completed you will need to log in to your PayPal account and set up the following options:

On your PayPal Account Page go to Account Settings, found by clicking on your account name on the top right hand corner, then to Website Payments and then update Website Preferences. In Website Payment Preferences select the following options

Auto Return: On

Return URL: <https://checkboxadmin.com/paypalreturn>

Payment Data Transfer (optional): On

Encrypted Website Payment: Off

PayPal Account Optional: On

Contact Telephone Number: Off

Express Checkout Settings: No

Press Save and then go back up to Payment Data Transfer (optional) and you will now have an Identity Token. ***It is very important that you copy this token carefully (using copy & paste) in the next step. We strongly suggest that you copy this token into a blank document to store for safekeeping.***

Once you have completed setting up your PayPal account and have copied your identity token, open the administration page on your CheckBox System and go to **Access Controls** on the top menu and then **PayPal Setup** in the drop down menu.

In the box marked PayPal Identity enter your PayPal ID (typically your email address).

In the PayPal Identity Token box paste your PayPal Identity Token.

Set your prices, and leave as zero's any time increments that you do not wish to offer. Press the Update button when done..

Increment	Price
1 Hour	0.00
2 Hours	0.00
1 Day	0.00
3 Days	0.00
1 Week	0.00
30 days	0.00
6 months	0.00
1 Year	0.00

There is a known issue with PayPal that can cause third party transactions with cents (i.e. \$1.99, or \$4.95) to sometimes process incorrectly. If you find some guest transactions are not processing try using whole dollar amounts (\$1.00, 4.00 etc.)

It would be a good idea at this point to run some sample charges through the system. You can refund those charges when you

are done testing by using the PayPal merchant tools in your PayPal Account Management Screen.

The PayPal software module is provided to process credit card transactions securely through PayPal utilizing PayPal's systems. CheckBox Systems is not affiliated with PayPal and does not offer support for managing PayPal merchant accounts.

Free Access

The Free Access System allows you to give your guests free access.

You can allow free access once per period, for example 15 minutes free every day, or 1 day free per week. This is great for a coffee shop or restaurant that wants to advertise free internet access but prevent guests from taking up a table for hours upon hours. The guests will still get your welcome screen when they first log on, and if they qualify for free access (if they have not had free access already in the predefined period) then they will be invited to try the access for free. Once the free period has expired the guest will be required to enter a valid ticket number or credit card (if you have those options enabled) and the free option will not be displayed for that guest.

If you wish to allow unrestricted free access to your customers, but still have the customers view your site welcome page, you can set the Trial Time and Trial Period time to be the same. For example; by setting the Trial Time and Trial Period both to 60 minutes, your clients will see the welcome page once every hour.

The screenshot shows the 'check box' web interface. On the left is a navigation menu with items: Dashboard, Administration, Access Controls, Customize Site, Mesh, and Network Setup. The main content area is titled 'Guest Network 2' and contains the following settings:

- Access Time (when Button hit):** A dropdown menu is set to 'Disabled (removes Free Button)'. Other options include 15 minutes, 30 minutes, 60 minutes, 2 hours, 8 hours, 1 Day, 3 Days, and 1 Week.
- Trial Period (Hide Button until):** A dropdown menu is set to '30 Minutes'. Other options include 1 Hour, 8 Hours, 1 Day, 3 Days, 1 Week, and 30 days.
- Bandwidth Tier for Free Clients:** Radio buttons are set to '100%'. Other options are '50%' and '25%'. There is an 'Update' button below this section.

To enable Free Access, select **Access Controls > Free Access Setup**. If you have two Guest Networks make sure you select the Guest Network you want to create Free Access for.

Select the Trial Time, how much time you want to allow them on the system, and then select the **Trial Period**, the amount of time that must elapse before they get a new free trial.

Press **Update**.

You may also customize the message your users see by selecting **Customize Site > Free Access Text** and editing the message.

Bandwidth Tiers - You can set the amount of bandwidth that Free Access users receive relative to others (ticketed, PayPal and Permanent users). Bandwidth Tiers allow you to provide a basic level of service free to customers while providing other users a higher level of service. If you set the *Bandwidth Tier for Free Clients* to 100%, then users pushing the Free Access button will get the same amount of bandwidth as all other users. You can also select 50% or 25% bandwidth level, providing Free Access users 25% or 50% of the bandwidth other users get, as determined your setting under the Client Usage Policy setting.

PermaCode

PermaCodes are reusable codes you can define. Usage is similar to ticket numbers, but these codes are reusable by multiple guests at the same time. You may change PermaCodes at anytime, and devices previously activated will remain activated until the time set for their code has expired. PermaCodes are great for group events or special promotions and can save the need for printing and distributing large amounts of tickets for one time events.

You can have two different PermaCodes in use at a time, with different amounts of access time assigned to each code.

To set up PermaCodes click on the **Access Controls > PermaCode** button on the drop down menu. If you have more than one Guest Network make sure you select the Guest Network you want to create PermaCodes for.



Create your code word(s) and select the amount of time each code word is valid for and press update.

Guests enter the code into the box on the welcome page, and they will be on-line.

PermaCodes can include letters and numbers, but not spaces or special characters. To make it easier for guests PermaCodes are not case sensitive.

Room Prompt Setup

No matter if you use Free Access, Tickets or PayPal you can also require users to list their room number, campsite or boat slip location using Room Prompt.

Selecting Room Prompt adds a second box to the welcome page that the guest must enter information into and the information entered will be listed on the Active Clients Screen next to the user.



To enable the Room Prompt, go to Customize Site then Room Prompt Setup. Select **Enabled** to turn on room prompts, and optionally you can change the text that appears above the prompt box. If you have two Guest Networks make sure you select the Guest Network you want to create tickets for.

Once Room prompts are enabled, in addition to clicking Free access, entering

a ticket or PermaCode, guests will be required to enter information and that information will be listed in the Active Clients table.

Although CheckBox can not validate the information provided by guests, the guests will be required to enter information, and if your staff notices invalid information listed under Active Clients (bogus room numbers or locations) they can disable the user.



Ticket	Time Left	Room	Traffic	Network	Mac	AP	Sig Policy
Free	29 min	118	0	Guest	192.168.10.139	C2ee97be74a0	44D1FAACB91 0

Customizing your Welcome Screen

As you enable access methods the system will add the appropriate buttons and boxes to your welcome screen. You can customize the look of your welcome screen by uploading a picture or logo and changing the messages on the screens your guests will see.

To upload an image click on **Customize Site** in the top menu and then select **Update Site Logo** on the drop down. If you have multiple Guest Networks make sure you select the correct network.

To change the messages your guests see select **Customize Site** and then choose what item you would like to customize.

You can choose to change the **Site Logo**, the message on the **Login Screen**, the message on the **Welcome Screen**, and the messages users see when their login fails or abuse of the service is detected.

When editing text you will notice some html tags in the default text. If you are not familiar with html code you can just change the default wording in these sections. If you are familiar with html you can customize fonts and colors and add references to external graphics and elements with html. If you reference external elements be sure to add their locations to the whitelist (found under Administration > Open Systems).



After your guests successfully login they will see a Welcome Message. If their ticket number or Permacode is not valid they will see a Failed Login Message. These messages can also be customized by selecting the options in the drop down menu under **Customize Site**.

Uploading Graphics

CheckBox provides the option to upload a graphic for the welcome page and a different graphic that prints out on the tickets. Your guests will be accessing your CheckBox with devices that have different screen sizes. The graphic that you upload may look great on a desktop or laptop with a large screen, but be too large for a smartphone or tablet.

For best results these graphics should not be too large, either in pixels or file size. Pixels refers to the number of dots in a picture, these dots making up the picture itself. If a picture is described as 200 x 400 pixels, the picture is 200 dots wide by 400 dots tall. If the pixel count is too big then the picture may not fit on the page or it may push other elements of the page off the screen. Remember that not all screens are the same size. It may look fine on your screen but may not fit on somebody else's screen!

File size refers to the amount of data used to record the picture information. Too little data and the picture looks blurry or grainy. Too much information and the picture takes too much space in storage and takes too long to download.

So what is the "right" size? For the welcome screen logo generally an image that is no bigger than 320 pixels wide and 120 pixels tall works best. You can make them less wide or less tall. As for file size, somewhere between 20Kb and 60Kb is about right. CheckBox will not accept graphic larger than 100Kb in size

For the Welcome Screen CheckBox can accept files in .jpg, .bmp and .gif format. Most devices can display all three formats.

For the logo on your ticket, an image that is 110 pixels tall by 200 pixels wide is ideal, with a file size around 20 kb.

There are many tools you can use to resize your graphic, including Adobe Photoshop, and shareware tools such as Irfanview (<http://www.irfanview.com>).

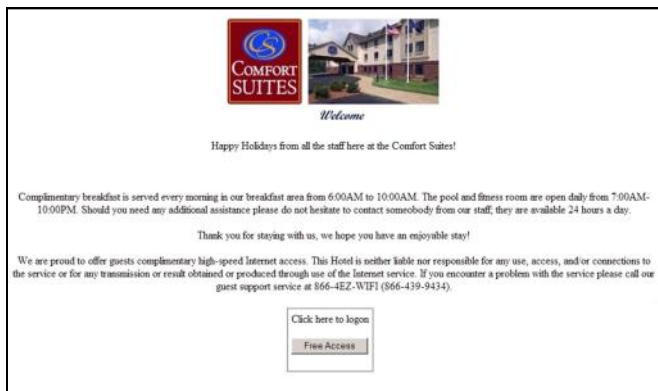

An example of a welcome screen

Accessing Your System from Outside

If you have your CheckBox connected to your company network you can access the System Administration Screens from any device on your network, even if these devices are not connected to the CheckBox system. In order to access your CheckBox from your office network or router you will need to know the WAN IP address assigned to the CheckBox by your network. If you have access to the System through a wireless client you can find this address in the System Administration Screen by clicking on **Network Setup** and then **Internet**.

You will see a list of all the Internet connection(s) to the CheckBox. Note the IP listed in each section. This is the IP address assigned by your ISP or internal router to the CheckBox.

SFP+ X0		
Mac: 60:BE:B4:1B:A2:14	Ethernet: 10000Mb/s	Duplex: full
Ip: 192.168.10.78	Netmask: 255.255.255.0	Gateway: 192.168.10.1
Recent Data Rate: 960.0 bps	Maximum Data Rate: 65.0 Mbps	Loadshare: 30%
Recent Uplink Rate: 0.0 bps	Maximum Uplink Rate: 138.7 Kbps	
<input type="button" value="Setup"/>	<input type="button" value="Link Speed Test"/>	

eth5		
Mac: 60:BE:B4:14:25:BB	Ethernet: 2500Mb/s	Duplex: full
Ip: 192.168.10.30	Netmask: 255.255.255.0	Gateway: 192.168.10.1
Recent Data Rate: 960.0 bps	Maximum Data Rate: 19.8 Mbps	Loadshare: 10%
Recent Uplink Rate: 0.0 bps	Maximum Uplink Rate: 713.8 Kbps	
<input type="button" value="Setup"/>	<input type="button" value="Link Speed Test"/>	

Once you have determined the IP address assigned to your CheckBox by your network you can access it by entering the IP address in the address bar of your web browser with **http://** in front of the address and **:3456/admin** after the address. For example, if the IP address assigned

by your network to the CheckBox was 192.168.10.78 enter **http://192.168.10.78:3456/admin**.

This will bring up a password login box just as it would if you were connected from inside the system, and all administrative functions are accessible.

Accessing Your System From Anywhere - The Easy Way

You can also access your system remotely using Remote Site Login. This service is available at no cost for any system covered under the original warranty or an extended support agreement.

To use Remote Site Login you will need your site ID number, user name and password. The site ID number is a four digit number assigned by CheckBox Support. Your user name is also assigned by CheckBox Support. Your remote access password is the same password that you use to access your CheckBox System when you are logging in directly to the CheckBox. If you do not have a site ID number and user name, please contact support@checkboxsystems.net to request one.



To start go to MyCheckBoxLogin.com and in the Site Login box, enter your 4 digit site ID number then press **site lookup**.

A login box will pop up, requesting a username and password. Enter your user name and password and press **OK**.

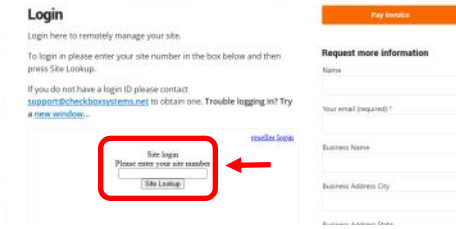

You will see a summary of your system status as last reported to the CheckBox support system. You are not yet in your local CheckBox control panel.

Typically your system status is updated every 10 minutes. Any unit highlighted in green is working. Any item highlighted in yellow, pink or red is experiencing a malfunction. A unit highlighted in blue is currently undergoing a software update.

Click on the Name of your Site (the first item listed under **Location**) and you will be connected into your CheckBox System.

Hotspots			
Location	Status	Version	
Oasis GH	0-03	4.400MCx	Statistics
ABB 2nd Floor	0-00	4.400Sa	
ABB 3rd Floor	0-03	4.400Sa	
ABB Office	0-01	4.400Sa	
OGH 2nd Floor	0-03	4.400Sa	
OGH 3rd Floor	0-01	4.400Sa	
OGH Office	0-04	4.400Sa	

If you receive an error message after clicking on the name of your site then your site is not accessible. Possible reasons for a site not being accessible include your CheckBox system being off-line (either the system is down or the internet connection to the system is not functioning) or the CheckBox system is behind a firewall.

Accessing Your System From The Internet

There are two ways to access your CheckBox System remotely through the internet. The first way is to log in through the CheckBox Support System at www.checkboxsystems.net. There you will find a link to log into your CheckBox system from anywhere. The second way is to log on directly to your CheckBox via the system's IP address.

In order to access your CheckBox System through the CheckBox Support web site you will need a site number and user name. Please contact support@CheckBoxSystems.net to obtain your Site number and user name. CheckBox Support will respond with your remote ID and instruction on how to use it to access your system.

You can also access the CheckBox remotely by IP address. If your CheckBox is connected to your modem through a router, you will need to enable static routing, DMZ, or virtual servers through your router. *Please refer to your router manufacturer's instructions for details on how to enable static routing or virtual servers. Due to variations between different router models CheckBox support can not assist with making changes to your office router.*

In order to access your CheckBox from the internet, you need to know the IP address assigned to you by your internet service provider. An IP address is a unique number much like a telephone number that identifies a unique machine on the internet. No two IP addresses can be the same on the internet. Most ISP's use dynamic IP addresses which may change periodically, in order to conserve the pool of available IP addresses. Some ISP's will provide a static (non-changing) IP address upon request, and may charge for this service.

To access CheckBox through the internet you will enter the IP address assigned by your ISP in the address bar of your web browser with **http://** in front of the address and **:3456/admin** after the address. For example, if the static IP address for the CheckBox was 66.23.124.9 then you would enter **http:// 66.23.124.9:3456/admin**

This will then bring up a password login box just it would if you were connected from inside the system, and all administrative functions are accessible.

Administering Client Devices

Under normal circumstances guests will get online, use their time and then automatically be logged off the system without any intervention from you or your staff. However there are options to manually adjust a guest's time remaining, delete a guest from the system, and manually authorize a guest device.



The screenshot shows the 'Administration' section of the CheckBox system. Under 'Activated Hotspot Clients', there is a table with columns: Ticket, Time Left, Room, Traffic, Network, IP, Mac, AP, Sig, and Policy. The table contains three rows of data. The first row has a green background for the 'Policy' column. The second row has a green background for the 'Policy' column. The third row has a green background for the 'Policy' column.

Ticket	Time Left	Room	Traffic	Network	IP	Mac	AP	Sig	Policy
Free	1 9 hrs	110	0	Guest	192.168.19.139	c2:ee:97:ba:74:a0	48D1FAACE81	0	
Free	56 min	325	0	Guest	192.168.18.28	e0:aa:96:ad:68:56	48D1FAACE81	143	
Free	10 min	42	Admin	192.168.17.24	52:34:82:84:97:08	48D1FAACE81	143		

Selecting **Administration > Active Clients** you will see a list of all clients currently ticketed. Client devices are listed by their MAC address and IP address. You can see their time remaining and by clicking on their ticket number or

time left you can manually add time or delete the client from the system. You can also rename the ticket to identify users or devices.

The Network Traffic column lists how much data traffic they have put through the system. This information is counted from the time they activate their ticket.

Other columns list the access point that the client is connected to and the strength of the signal that the system is receiving from the client. In most cases, signals greater than 15 should result in a good connection. These signals are averaged over a 5 minute period, and it is normal for these to fluctuate.

Selecting **Offline Clients**

you will see a list of all clients that have been authorized on the system and still have time remaining but are currently not online. These devices can rejoin the network without going through the welcome screen until their time remaining expires.



Selecting **Administration > Unauthorized Clients** will display a list of all devices that have found the network but are currently not allowed to go onto the Internet. It is not unusual to see several devices in this list, as most WiFi devices will automatically search for available networks.



Manually Authorizing Devices

If you want to manually authorize a device for Internet access (for example a device that does not have a web browser like a credit card terminal or a game console) you can authorize it by going to **Unauthorized Clients**, select the client from the list, clicking in it's ticket column (which will in dictate a ticket of none) and selecting an amount of time for it to be allowed to access the Internet.

If there are multiple devices in the list you may be able to identify the device you want by it's name, MAC address or IP address. However if you can not determine which is the item you want to authorize try these steps:

1. Power off the device > you want to authorize.
2. Press the Clear List button on the Clients not Authorized screen.
3. Power up the device and make sure it connects to the CheckBox WiFi.
4. Refresh the Clients not Authorized screen and that device should not be the only device shown.

Labeling Users

For easy identification, you can change the label name for a user in the system. For example, if you have several computers in the office that are permanent clients, and some users that are employees with long term tickets, you can label them by their name.

To change the label of a user, simply click on their ticket number in the ticket column (If they used PayPal, Free Access or if you enabled them manually click on the PayPal transaction number, "Free", or "Manual" label in the ticket column). Enter the new label or name in the box marked "Identity" and press **update**. When entering a name or label, do not use spaces or special characters.

Client Usage Policy

With the Client Usage Policy you can limit how much data guests can use. While most guests will never reach their bandwidth limits, some attempt to download or stream large files and could negatively impact other guests. If you use satellite Internet or if your ISP has a daily or monthly download limit, one guest could consume your entire data allotment.

The last column in the Activated System Clients table shows the Client Usage Policy status of each individual user. If the policy box is green, the user has full access to available bandwidth. If the policy box is yellow, the user is approaching the bandwidth limit set and their speed has been reduced. The reduced speed will be displayed in the yellow box.

Ticket	Time Left	Contact Info	Network	Ip	Mac	AP	Sig	Policy
Free-1a	57 min	211	Guest	192.168.19.139	c2:aa:97:ba:74:a0	Office	0	Unrestricted IP
Guest-Net-A-2015	3.0 days	189	Guest	192.168.19.29	e0:aa:95:ab:68:56	Pool	45	
None	6.9 days	0	Admin	192.168.17.23	0c:50:ca:03:07:47		0	
anon	7.9 hrs	20	Guest	192.168.19.14	00:15:af:69:42:51	Pool	70	

Usage status for:
Identity/Code: Free
Client Adapter: 0c:30:21:56:87:4
Recent download: 0% of Policy
Recent upload: 0% of Policy
Bandwidth Limiting: None
Active Connections: Disconnected

Reset Usage Counters
 Automatically Managed
 Unrestricted Usage

You can set exceptions to the usage policy for individual users to allow them unrestricted bandwidth - this is handy for office computers and devices. To set a device for unrestricted bandwidth click on the green or yellow policy box and a screen will open that allows you to select unrestricted usage. You only need to set unrestricted usage once per ticket, and the user will remain unrestricted until their ticket expires. If this is for an office computer consider setting a Permanent ticket by clicking on the ticket number and setting it to Permanent.

Setting the Client Usage Policy

By default the Client Usage Policy is disabled and each guest can use as much data as they wish.

To turn on the Client Usage Policy go to **Administration > Client Usage Policy**. You will see the option to enable the Client Usage Policy for each active network.

Network Bandwidth Management Settings

Guest Network
 Bandwidth Management

Admin Network
 Bandwidth Management

Once Bandwidth Management has been selected a slider will appear to allow you to set the amount of bandwidth given from Min to Max, or you can set specific limits.

Using the Min to Max sliders sets a *relative* limit; the system limits users based on the total bandwidth coming in from your ISP and the total number of active users relative to the other networks. This allows users on a network set to Max several multiples of the bandwidth given to users on a network set to Min. The actual amount of data provided to each user will vary depending on how busy the system is and how much bandwidth the ISP is providing.

Users on a network set to a customized Bandwidth Limit will be allowed up to that much data per hour.

Users are not cut off, instead as they approach the limit the system will begin to progressively throttle their speed to prevent them from going over the limit. Some applications (ex. video streaming) will stop if the connection gets too slow. Users that are throttled are highlighted in Yellow in the Active Clients display. A few minutes after the user backs off on their consumption the system will automatically reduce the throttling.

Network Statistics

You can see total data amounts consumed by your CheckBox System under Network Setup -> Statistics .

Here you can see inbound and outbound data usage for your system for the past 30 days, and also see historical usage over the past twelve months.

Data highlighted in blue and marked **rx** is data that was downloaded from the Internet. Data highlighted in brown and marked as **tx** is data that was uploaded to the Internet.

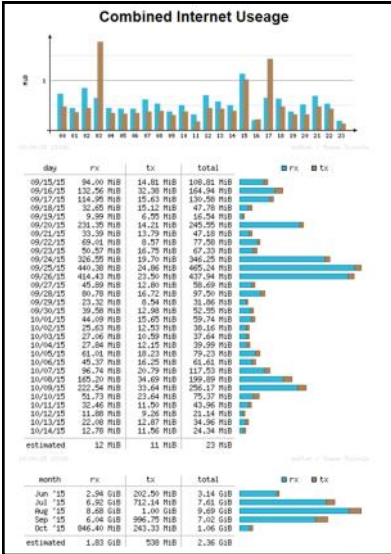

By selecting the Hourly link at the bottom of the page you can view the total system usage for all of your modem connections combined.

You can also view usage for each Internet connection ("Adapter") on an hourly basis. This can help you see how your different Internet connections perform throughout the day.

By selecting the Monthly link at the bottom of the page you can see a summary of the last thirty days of total system data usage.

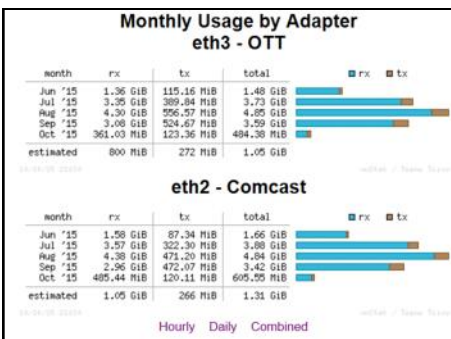
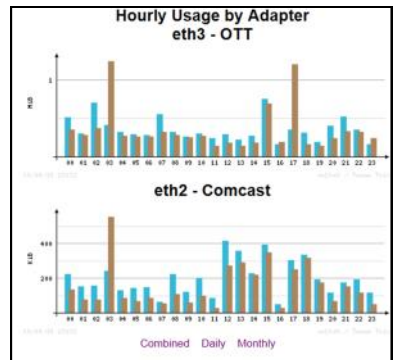

Signal Strength, Power Levels & Antennas

Communication between your guest's devices and the CheckBox is a two-way transaction, not a one-way transaction like radio or TV broadcasts. For a successful connection not only does a signal need to get from the CheckBox to the user's device, but they need to get a signal back to the CheckBox. Portable WiFi devices are not all created equal and few have an external antenna. It is not unusual for a device to "see" a signal of a few bars, or "good" but have a difficult time maintaining a connection. This is usually a case of the WiFi device seeing the signal from the CheckBox but the WiFi device does not have the strength to call back to the CheckBox.

Speaking of signals - signal strength displays are an approximation of the signal strength averaged over a period of time and do not take into account signal noise, the interference inherent in every radio transmission. Users may see a strong signal displayed, but due to noise and interference they may still not be able to establish a connection. The opposite can also occur; sometimes users will see a weak signal and still have a solid connection. Regardless of what the signal strength display reads the bottom line for the user is always

Can they connect and is the connection fast enough?

One way to improve the range of the signal is by adding a long range antenna to your access point. Long range antennas can sometimes help and sometimes can make the situation worse. While a standard antenna sends out radio waves equally in all directions like a balloon, long range antennas achieve greater range by changing the shape of the signal, flattening out the balloon into more of a donut, sending less of the signal straight up into the sky and more out towards the edges. These antennas can generally extend the usable range from 10% to 30%. However they can introduce two new problems; the case of the WiFi device seeing the CheckBox but the CheckBox not being able to WiFi device mentioned above, or a case where the "donut" is so flat that it shoots over the heads of the users.

A second type of antenna re-shapes the signal even more, sending it in a pinpoint beam. These antennas can increase range ten-fold or more, however if the user is not in the direct path of the signal they will not be able to see it. Even if they are directly the path of the signal, if they are not able to send a signal back they will not be able to establish a connection. These high-gain point-to-point antennas are best used in pairs, one on each end of the path, and while not practical for guest WiFi devices they are good for connecting buildings in remote locations or repeaters in areas not contiguous to other units.

Another way to improve range is to increase transmit power. Since we do not have control over the quality of the user's devices we cannot affect their transmit power, but we could boost ours. CheckBox already uses the maximum legal power in the frequencies (channels) it occupies. There are WiFi "amplifiers" that can boost power, but these are not legal. Unlicensed operation at higher power can result in the property owner being fined.

When you boost the transmit power on one end of the connection but not the other you also run into the problem of one side being able to see the signal from the other side but not being able to send a signal back.

Since consumer WiFi devices do not have good antennas and do not generally use the maximum output power they really benefit from having a high density signal. The best way to have a high density signal is by using multiple access points.

Determining the proper number of access points requires taking into consideration several factors:

How much area do you need to cover? What are the surroundings? Are there walls or open spaces? Is the building made of wood, rebar reinforced concrete, or steel? Is there any interference in the area?

On a flat open field with no interference a signal can travel up to 1000'. When we start adding walls, other wireless devices and users, that distance will begin to shrink.

For example, a hotel with two wings each 200 feet long and three floors per wing, made of rebar reinforced concrete, might need 16 or more access points to provide solid coverage. Another hotel, constructed of wood but with similar dimensions, may only need 8 access points to provide coverage.

Another example would be a campground that is on an open flat field. To provide complete coverage however you need to penetrate the aluminum skin of the RVs which might require access points spaced every 200 feet, so that no RV is more than 100 feet from a unit.

If that hotel happens to be at the end of an airport runway with a radar system nearby or that campground has a cell tower in the middle of the property then interference from those devices may require additional units to overcome the interference.



Meshing Access Points & Mesh Node Status Display



CheckBox meshing access points are self-configuring. As long as they can receive a signal from one of their peers or the controller they will establish a connection among themselves and actively determine the best route back to the controller unit.

Meshing access points can run as wired access points, connecting back to your CheckBox Controller with a wired connection, or as wireless meshing access points, connecting automatically back to the controller wirelessly. When run in a wireless mesh configuration the access points still need to be connected to a nearby power source. Performance in wireless meshing mode will depend upon the signal strength of the wireless signal received from the system as well as noise and wireless interference. Generally overall throughput will not be as good as if the access points were wired; wireless meshing works best in applications where running a connection back to the controller is not possible.

IMPORTANT: The first time a mesh repeater is added to the network it will show up highlighted in **blue** in the mesh status display. Until you click on this access point to accept it into the system it can not service clients or pass traffic. You must click on blue units to allow them to join the system. This only needs to be done once, and after a unit has joined the system it will be remembered by the system, even after power failures or prolonged storage. Labeling the repeaters here makes it easier to remember where they are located.

Once your access points are in place you can monitor their status by selecting **Mesh > Mesh Nodes**

The first column identifies the access point by it's MAC address, the electronic serial number used to identify network devices.

The second column shows the units name or location; you can change this label by clicking in this box and entering a name or location. By default it is a row of "*****" You also will click on the row of "*****" the first time a repeater is added to a system to allow it into the mesh.

Unit	Location	Connection	Signal	Link	Chan	Chan	Clients
60BEB41425B6	Controller						0
44D1FAACAE91	Office	Controller	Wired	2500	11	36	0
44D1FAA376A9	Pool	Office	62	144	6	38	0

The third column shows the name or location of the unit from which this unit gets it's connection, this may be the CheckBox controller or another repeater if the units have daisy chained themselves. Mesh repeaters are constantly evaluating their connections and "talking" to other repeaters and the controller to determine the best route back to the controller and the internet. You may see this change occasionally as the system reconfigures itself to deal with changing conditions.

The fourth column shows the current signal strength of this unit to it's upstream

connection. The signal strength is a 5 minute average, and it is normal for this to fluctuate. Any unit with a low signal strength will be highlighted in Yellow or Red. Units highlighted in yellow will have slower connections that will be unreliable. Units in Red are not able to support traffic or users as they have a very low or no connection (often as the result of issues with power or wiring at the unit). The signal is only displayed for access points running in wireless mode (access points without a wired Ethernet connection to the CheckBox), any wired units will display "wired" in this column.

The fifth column shows the Link speed, the maximum speed data can travel over this link. Other factors may cause actual throughput to be lower.

The sixth and seventh columns indicates what channels the access point is operating on. Systems with multiple wired access points can change the channel of each wired access point by clicking on the unit name and adjusting the preferred channel accordingly.

The last column shows how many clients are using this access point.



Final Installation Checklist

After you have completed installing your system use this checklist to make sure everything is ready for your guests.

Physical Installation - CheckBox

- CheckBox controller unit is connected to power.
- CheckBox controller unit is connected to internet connection(s).
- Network connection cables are not stapled to walls or cable tied to AC wiring or power lines.

Physical Installation - Access Points

- Access points are connected to power.
- [Outdoor units only] Access points are mounted at least 20 feet above ground.
- Access points are mounted at least 4 feet away from other antennas.
- Serial number of each repeater is noted for labeling by location in mesh display.

System Setup - CheckBox controller

- Set administrative password.
- Accept access points into network on the Mesh page.
- Upload your graphic for Welcome Screen and Tickets.
- Set up your Welcome Message.
- Change SSID(s) in Network Setup.
- Print out user tickets [for systems using tickets].
- Set up Free Access [for systems using free access].
- Set up PayPal credit card system [for systems using PayPal].

CheckBox S/A/F/E - Survey and Feedback Engine

CheckBox includes the S/A/F/E Survey and Feedback Engine, a system to provide direct and ongoing communications with your guests to increase guest satisfaction.

With CheckBox S/A/F/E - The CheckBox Survey and Feedback Engine - your WiFi does more than just connect your guests to the Internet. S/A/F/E lets you reach your guests - and your guests reach you - instantly and easily via any connected device to increase customer service and guest satisfaction.

With the CheckBox Survey and Feedback Engine as soon as your guests log onto your WiFi your CheckBox automatically sends a welcome message via email or text. This welcome message includes any information that you want your guests to know and they can reply to the message to ask you or your staff questions, make requests or to let you know about any issues that need to be addressed.

The CheckBox Survey and Feedback Engine routes messages between you and your guests to any desktop or portable devices you designate, allowing easy and quick follow up - a great way to save time while increasing guest satisfaction and engagement.

Guests can get their questions answered quickly without trekking to the office or hunting for a staff member, and staff can handle guests issues quicker with less interruption of other tasks.

CheckBox S/A/F/E is available to all CheckBox Customers at no additional cost.

CheckBox S/A/F/E is another feature included at no additional charge to all CheckBox customers on a current support plan or under their original warranty.

The conversation doesn't stop when your guests disconnect from your WiFi or leave your property.

CheckBox detects when your guest has left the property, and after a predetermined interval can automatically send a follow up message you design thanking them for their stay and inviting them back. With the built in survey tools you can send a follow up survey to gather feedback and send follow up messages to invite them to return.



Setting up CheckBox S/A/F/E

To set up your S/A/F/E you will need to have your Remote Site Login ID number, your username and password. If you do not have these or have forgotten your them please contact Support@CheckBoxSystems.net to set these up.

Login to CheckBox and navigate to Customize Site then Survey and Feedback Setup.

In the area labelled Entry Field for Survey Contact Info click on the button marked Enabled to turn on the S/A/F/E feature.

checkbox

Dashboard

Administration

Access Controls

Customize Site

Mesh

Network Setup

Checkbox S/A/F/E Setup

Checkbox Survey and Feedback Engine

To enable Survey and Feedback, First click on the button below to set up your survey parameters on the survey portal
Then return to this page and complete the setup below.

[Setup Survey Parameters](#)

Enabling this option will add another selection to your customer login page
Clients will be asked to include an email address or text message number for survey and feedback.

Entry field for survey contact info
 Disabled Enabled
 Optional Required

Field Header (prompt)

```
Please share your contact info
<br>
- either mobile number or email address -
<br>
with us to help us better serve you.
<br>
We will not share or sell your information.
```

[Update](#)

Enabling this option will add another entry field to the Hotspot login page Users will be prompted to enter a value into this field, which will be displayed along with the ticket number in the client management screens. By asking users to enter contact information during login, this value will be used to send satisfaction surveys by email or text message.
For security reasons the Survey and Feedback system will not capture information on PayPal transactions and will not be able to provide message service and feedback surveys to guests using PayPal to log onto the Guest WiFi. If you have multiple methods enabled (i.e. tickets, Permacode, Free Access) and PayPal, any guest logging on with any method other than PayPal will still be able to use the message service and receive surveys.

The CheckBox Welcome page will now have a field where guests can enter either their email address or mobile phone number for texting. You can make it either optional or mandatory to enter the address or mobile number.

In the field header prompt you can customize the message the guest sees when asked for their email or mobile number.

Your guest log in screen will have this area added where your guest then shares their email address or mobile number.

Your actual login screen will look different depending upon the graphics you have added and other options you have enabled.

LA QUINTA
INNS & SUITES

Internet Access Available Here

Use of this service constitutes agreement with the Terms of Service listed below.
If you do not agree with the Terms of Service you may not use this service. <

Please share your contact info
- either mobile number or email address -
with us to help us better serve you.
We will not share or sell your information.

Contact Info

[Click here to accept terms & conditions and access the Internet](#)

[Free Access](#)

Next we need to setup the welcome messages and optionally the surveys.

Click on the Setup Survey Parameters button.



Login here with your Site number, Username and password.

This portal can also be used to remotely log in from anywhere to manage both your CheckBox Guest WiFi and your S/A/F/E Systems and can be reached directly by going to

<https://portal.checkboxsystems.net>



Once logged in you will first see a summary of your system status. You will see the name of your property, the names of your access points, and the status of your system. Any device highlighted in red is having issues and is not online.

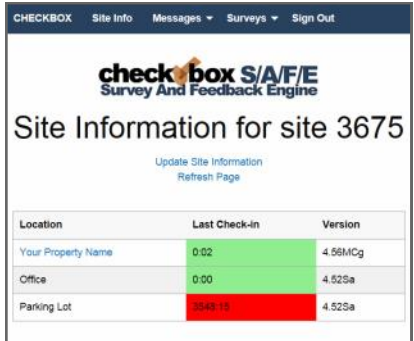

Navigate to Surveys and then Survey and Message Settings .

Here you will put in an address where messages from guests will be sent to. This should be an address that is monitored by staff or management to provide timely responses to guest issues.

The Send Survey After drop down setting is where you set a delay for when the system no longer detects the guest on property after which time a survey can be



Next navigate to Messages and then My Messages. Here you will set up the welcome message that is emailed or texted to every user.

Here you can add new messages to be sent and see a summary of all messages that you have already created and are available to choose from.

Click on the Add New Message button.

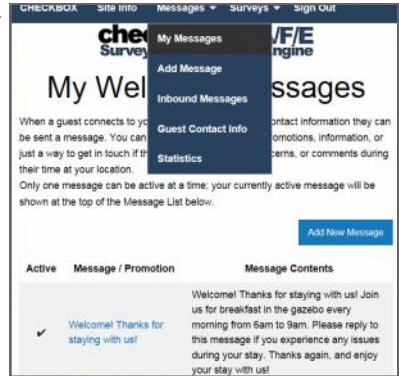

On this page you will create the welcome messages emailed or texted to your guests when the first connect to your CheckBox.

You can create multiple messages and save them, but only one message at a time can be active.

Since guests have the option of supplying an email address or a text address we have to format the message two different ways to accommodate the different formatting of the two types of messages we may be sending.



The Welcome Message Title / Email Subject box is the subject line of emails sent.

The Text Message Content box is where you enter the text message that will be sent. Text messages are limited to 140 characters total, including spaces, so messages must be short and sweet.

The Email Message Content is where you enter the message sent to email users. You have more room here and can add more information as appropriate.

To the right of the Welcome Message Title line is a box you can toggle to make the message active or not. You can create and save multiple messages, however only one can be active at a time. You can also choose to have none active and no message sent.

At this point your welcome message has been set up, and your guests can reply to your welcome message to ask questions or notify you of issues, and you can reply to those message - providing a convenient two-way messaging platform for you and your guests.

Receiving & Responding to Messages w/ S/A/F/E

If a guest replies to their welcome message that reply will be sent to the management email address you entered in the Survey & Message Settings screen and will be forwarded to your email inbox. Regardless of whether or not the guest is using texting or email, all messages will be automatically consolidated and sent to your email box.

From your email box you can reply to guest emails directly.

How late is the fitness center open?



If the message from the guest originated as a text messaging there will be a link in your email to click on to reply to the guest message. This link will take you directly to the guest's message in the CheckBox Portal.

You can also read and reply to text messages from your portal page. The most recent messages will be listed at the top of the list, and just click respond to reply.

Site Info Messages Surveys Sign Out



SMS Messages Received

Message From	Received	Mobile Registered in	Message	Last Visited	Action
3	11 Apr at 04:24	CA US	I s	8 Apr at 04:20 - Sunbeam Lake RV Resort x86	Respond
2	11 Mar at 16:03	BC CA	Hc off	10 Mar at 15:38 - Sunbeam Lake RV Resort x86	Respond
6	8 Mar at 03:08	CA US	W	7 Mar at 22:12 - Sunbeam Lake RV Resort x86	Respond
9	7 Mar at 17:56	BC CA	Nc	7 Mar at 17:51 - Sunbeam Lake RV Resort x86	Respond
1	3 Feb at 22:32	CA US	Th rel message.	2 Feb at 20:59 - Sunbeam Lake RV Resort x86	Respond

Creating Guest Surveys with S/A/F/E

You can use S/A/F/E to automatically send out a survey to your guests after they have left your property. CheckBox will monitor the guest's connection, and when they have disconnected from the network after a waiting pre-determined interval they survey can be automatically sent. This interval is set under Surveys -> Survey & Message Settings.

After the system has determined the guest has been off of the network for the predetermined time an email or text message will be sent inviting the guest to click a link to take your survey.

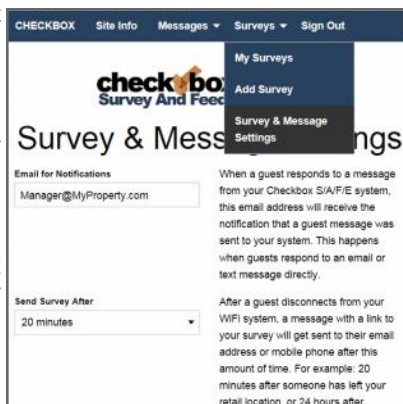

To create a survey navigate to Surveys -> Add Survey.

You can create and save multiple surveys, but only one survey can be active at a time.

Give your survey a title and create a message to go above your survey.

Survey questions can either be formatted so the responses are either a rating (1 through 5) or a comment field. Create your survey questions. Here you can also choose if this survey is currently active or not.

After you save the survey you can return to edit the questions if needed.

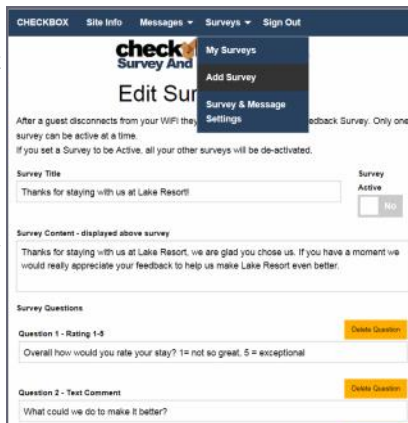

To see a list of the surveys you have created and to review the responses you have received navigate to Surveys -> My Surveys.

There you will see a list of all of your surveys and which one is active, and you can view the responses received by clicking on the View links on the right hand side.

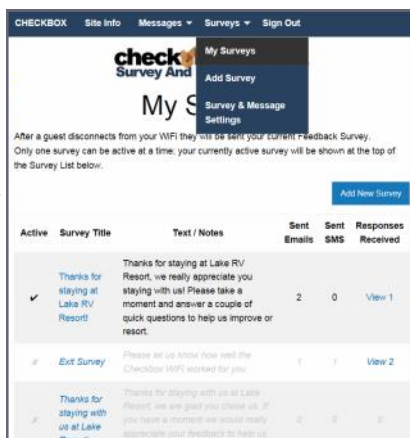

S/A/F/E Guest Contact Information

You can view and download the contact information for your guest by going to Messages -> Guest Contact Info.

Here you find a list of when the guest first and last connected to your CheckBox and their email or mobile number.

You can download this information to use in a spreadsheet or marketing program by clicking on the Export Customer Details button. The information will be downloaded as a .CSV file.

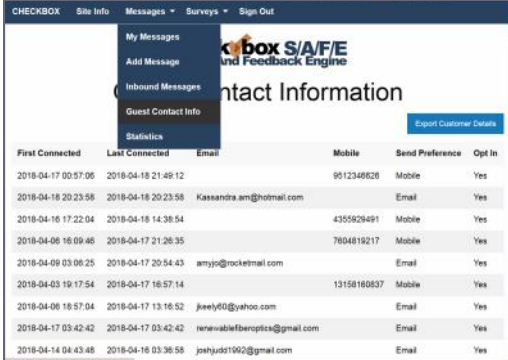

First Connected	Last Connected	Email	Mobile	Send Preference	Opt In
2018-04-17 00:57:06	2018-04-18 21:49:12		9512346626	Mobile	Yes
2018-04-18 20:23:58	2018-04-18 20:23:58	Kassandra.am@hotmail.com		Email	Yes
2018-04-16 17:22:04	2018-04-18 14:38:54		4355829491	Mobile	Yes
2018-04-06 16:09:46	2018-04-17 21:26:35		7604819217	Mobile	Yes
2018-04-09 03:06:25	2018-04-17 20:54:43	amyjo@rocketmail.com		Email	Yes
2018-04-03 19:17:54	2018-04-17 16:57:14		13158160837	Mobile	Yes
2018-04-06 16:57:04	2018-04-17 13:16:52	jjeely6@yahoo.com		Email	Yes
2018-04-17 03:42:42	2018-04-17 03:42:42	rene@ablefiberoptics@gmail.com		Email	Yes
2018-04-14 04:43:48	2018-04-16 03:36:58	jshjudd1992@gmail.com		Email	Yes

System Alerts

You can receive an email or text message if your CheckBox controller unit, one of your repeaters, or your internet connection goes off-line. These System Alerts are issued by the CheckBox Support Server, which monitors your system. This monitoring service is included in the first year warranty that comes with every CheckBox System, and is also included in the Extended Warranty Program.



Before you can set up alerts you will need a Remote Site log-in. If you do not have a remote site log-in you can request one from CheckBox by sending an email to support@checkboxsystems.net.

To set up alerts for your CheckBox;

1. Log in to the CheckBox support portal.
2. After logging into the support site click on "Site Info" and then the "Update Site Information" link in the middle of the screen.
3. Set your Alerts to either Aggressive, Normal or Relaxed (or you can disable alerts).
4. Enter the email address you want the alerts sent to.
5. Click the "Update Site Information" button.

Location	Last Check-in	Version
Live Demo	0:03	4.56MCG
Office	0:01	4.52Sa
Parking Lot	0:00:00	4.52Sa

The first time you activate the alerts for your CheckBox system, the support system will need to download some configuration updates to your CheckBox units, which may take up to 4 hours to complete.

Setting alerts to Aggressive will generate an alert if a CheckBox mesh node or a controller unit is late for any of its scheduled check in cycles. This may cause an excessive amount of alerts to be generated if your system is on a slow or unreliable Internet connection (such as satellite or older DSL). It is not uncommon for a unit to be late or to miss a check in cycle due to network congestion or high traffic.

Site Name: LIVE DEMO User Name: EVAL

Password: Email Alert Frequency: Disabled Aggressive/Normal Relaxed

Alert Email Address:

Setting alerts to Normal will generate an alert if a CheckBox mesh node or a controller unit two check in cycles. This is the setting most users will want.

Setting alerts to Relaxed will generate an email if a CheckBox mesh node or a controller unit fails to check in with the support server after four scheduled check in cycles. This setting is suitable for users with frequent power issues or issues with their internet service provider.

Many cell phone providers allow you to receive emails as text messages. If you wish to have the alerts sent to your cell phone as a text message, check with your cell phone provider as to the address format to use (often it looks something like yourphonenumber@cellphoneprovider.net) Some cell phone providers charge for incoming text messages. You may be charged by your cell phone provider to receive these messages.

Included and Optional Services

Included Warranty and Extended Warranty Support

Your CheckBox System includes a one year warranty from the date of purchase. This warranty includes:

- A hardware warranty with advanced exchange replacement
- Phone and email support for property management and staff
- Automatic software updates
- Access to the remote management portal
- Automatic email/text alerts of system outages
- S/A/F/E - the Survey and Feedback system

This warranty can be extended and renewed each year to provide ongoing coverage. Approximately two months before the end of your initial warranty and support period you will receive information on extending your warranty and support.

Guest Support

- ✓ 24/7 live support for guests and end users
- ✓ Dedicated toll free number
- ✓ Tracking of support incidents and escalation
- ✓ Can be used seasonally - no long term contract required.

Guest support is provided 24/7 by professional support staff at a dedicated support number. Support staff are available to assist guests connecting to the wireless service, configuring their wireless settings and logging on. Support staff have instant, real-time access to systems, can perform diagnostics, and when appropriate restart networks and alert property owners to issues, as well as escalating critical system issues to advanced technical support.

Guest support is priced on a per-room/per-campsite/per-boat-slip basis per month. *For more information or to order these services please contact CheckBox Support or your reseller.*

Support Options	Hardware Warranty & Standard Support	Guest Support
Support for Staff & Management	Yes	Yes
Support for Guests	No	Yes
Hours of Availability (Eastern)	9am to 7pm, Eastern Mon—Fri	24/7/365
Cost	First year included free. Can be extended after the first year, annual fee applies, varies by system size.	\$1.90 per guest unit (requires Hardware Warranty & Support if not under original warranty)

The following notice discloses the CheckBox Personal Data Collection and Handling policies.

CheckBox Systems LLC (hereafter referred to as CheckBox) is a provider of hardware and service solutions for certain sectors of businesses operating exclusively in the United States and U.S. territories.

During the course of normal business activity CheckBox or its agents on behalf of CheckBox may receive information from or about individuals, including but not limited to names, addresses and other contact information.

CheckBox may use the information it has received to market products services to current and prospective clients.

CheckBox may use the information it has received to provide services to clients or to client's customers on behalf clients.

CheckBox will not provide or share this information to any individual or organization outside of our business partner's and will only do so for use as needed to provide services to our clients and to market to potential clients. CheckBox does not sell any client information and does not share information outside of normal business operations (unless compelled by law).

Individuals wishing to have CheckBox remove their information should submit their request in writing to
Support@CheckBoxSystems.net
or submit their request in writing to the address on the bottom of this website.

The following notice discloses the privacy policy for the CheckBox Survey And Feedback Engine service.

CheckBox Systems LLC and its partners (hereafter collectively referred to as CheckBox) provide an optional service to its' clients known as the CheckBox Survey And Feedback Engine (hereafter referred to as SAFE or S/A/F/E).

CheckBox clients can opt to use SAFE to collect certain information, specifically email and/or mobile telephone numbers, at the request of and solely for use by our clients. Clients or their designated employees or agents may activate the SAFE service by selecting options inside of their CheckBox system that begin the collection process.

CheckBox will only collect information that is voluntarily provided by client's guests via the SAFE portal on the CheckBox WIFI system.

CheckBox employs industry standard best practices to protect this information both online and offline. The servers storing personally identifiable information are maintained in a secure environment.

In addition to technical protections only CheckBox employees who need access to the information to perform job specific tasks are granted access to guest information.

CheckBox claims neither ownership over this information nor makes any claim as to the validity of the information provided by client's guests. CheckBox will not provide, sell or rent this information to anyone outside of the client property (unless compelled by law). This information is only available to the client property that owns or operates the CheckBox System from which the information was collected. This information is only available via the CheckBox portal and the client or their designated employees or agents must initiate retrieval of this information via the CheckBox portal. CheckBox employees and agents are not allowed to furnish this information directly.

It is at the discretion of the client property that receives this information how to use it. It is the responsibility of the client property that receives this information to use it in accordance with applicable laws.

The following notice discloses what information CheckBox collects and tracks on individuals during data sessions using services provided by CheckBox Systems:

CheckBox Systems LLC (hereafter referred to as CheckBox) is a provider of hardware and service solutions for organizations to provide Internet connectivity to the public, typically, but not exclusively via WiFi.

CheckBox is designed to limit access to authorized users, limit data consumption and limited access to peer-to-peer file sharing services. Some or all of these features may be enabled or disabled by the property as the property sees fit for their needs.

In order to accomplish the above objectives CheckBox validates users by methods selected by the property that may or may not include disclosure of personal information and tracks user's device data consumption for the duration of the session. CheckBox does not store or record URLs, IP addresses accessed, or data sent or received by the user device.

CheckBox does not collect or store any user data from these sessions beyond the duration of the data session.

Properties may opt to use additional hardware from other vendors that filters, tracks or restrict access to certain URLs or IP addresses. Websites, apps or other service accessed by users may also track or otherwise record activity. End users assume responsibility for the security of their data and devices.

Revised 8/26/2021

These policies are subject to change.

Your Suggestions are Welcome

Many of the added features, improvements and refinements have been made at the suggestion of our users. We absolutely welcome your feedback and suggestions.

Warranties and Service

We have worked hard to design the best possible system for you and your guests. We want you be completely satisfied with your system. If you are not completely satisfied please let us know and we will try to make it right. If you are still not satisfied you may return the system in it's original condition within 30 days from the date of purchase for a full refund, less shipping and installation.

This system includes a one year warranty from the date of purchase and one year of standard support. This warranty covers repair or replacement of the components of the system as we determine necessary. The warranty does not cover damage due to improper installation, use of unauthorized accessories (including, but not limited to external antennas and power amplifiers) lightning, vandalism or physical abuse. Standard support is for use by the site management and employees and is provided via telephone or email at our option delivered during standard business hours. Standard support does not include guest support, on-site visits, after hours calls, or assistance with other network issues and items not related to this system. In no event shall CheckBox Systems be responsible for consequential damages due to the failure of this system or any of it's components. We reserve the right to terminate support in the unlikely event of excessive, or abusive calls. Under no circumstances will CheckBox Systems liabilities exceed the original purchase price of the product. This is a network access device, and the end user is ultimately responsible for network and data security.

System builds 4.600 & higher
CheckBox Systems, Copyright 2025